

Addressing the “Power-Aware” Challenges of Memory Interface Designs

One of the toughest challenges in designing memory interfaces is accurately measuring timing while also considering fluctuations in power and ground rails due to simultaneously switching signals. Signal integrity (SI) engineers are increasingly insisting on “power-aware” SI analysis, where the effects of signal and non-ideal power/ground are considered when analyzing high-speed memory interfaces. This paper assesses how modern tools can be used to address power-aware SI challenges associated with I/O modeling, interconnect modeling, simulation, and analysis.

Contents

- Introduction..... 1
- Power-Aware I/O Modeling..... 3
- Interconnect and PDN Modeling .. 5
- Simulation Environment 6
- Post-Processing and Analysis of Results..... 7
- Summary 9

Introduction

Memory interfaces are challenging signal integrity engineers from the chip level to the package, to the board, and across multiple boards. The DDR3 and DDR4/LPDDR4 speeds support multi-gigabit parallel bus interfaces with voltage swings smaller than previous generation interfaces. The data rates we see for DDR4 data buses today are right where we were initially for PCI Express® (PCIe®), at 2133Mbps and 4166Mbps. DDR4 I/O structures are similar to what we have historically had in the SerDes space. While signaling is still single ended, data buses have moved closer towards point-to-point topologies, and the interface on the controller side, feed-forward equalization (FFE, i.e., pre/de-emphasis) is becoming more and more common. On the power design front, LPDDR4 systems use very-low-voltage signaling (1.2V on LPDDR3 to 300mV on LPDDR4) to fit their applications in mobile devices such as smartphones, tablets, and Internet of Things. These new challenges in memory leave no room for error in any modern memory interface design.

Designing a memory interface has always been about timing closure. Each data signal’s timing needs to be compared to its related strobe signal in such a way that the data can be captured on both the rising and falling edge of the strobe, hence the term double data rate (DDR). The increase in data rates to more than 2Gbps has made the timing margin associated with each rising and falling edge much smaller (Figure 1)..

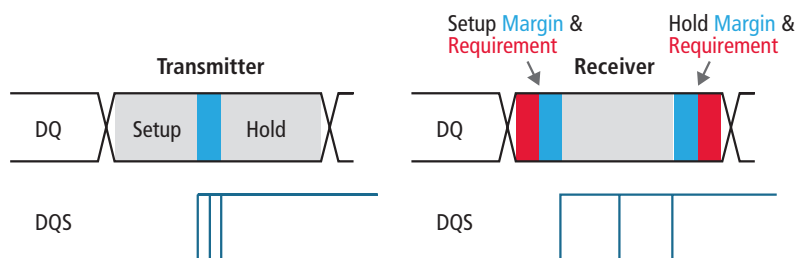

Figure 1: Source synchronous timing

However, today’s biggest challenge comes in accurately measuring timing while considering the fluctuations in power and ground rails that occur due to simultaneously switching signals. In the worst case, when all 64 bits of a data bus transition simultaneously, large instantaneous changes in current across the PDNs cause fluctuations in voltage levels that impact the timing margins of the transitioning signals (Figure 2). These signal switching variations are often called timing “push-out” or “pull-in.” If the time between data settling and the strobe transition is too much, meta-stable conditions can occur that would impact the data integrity.

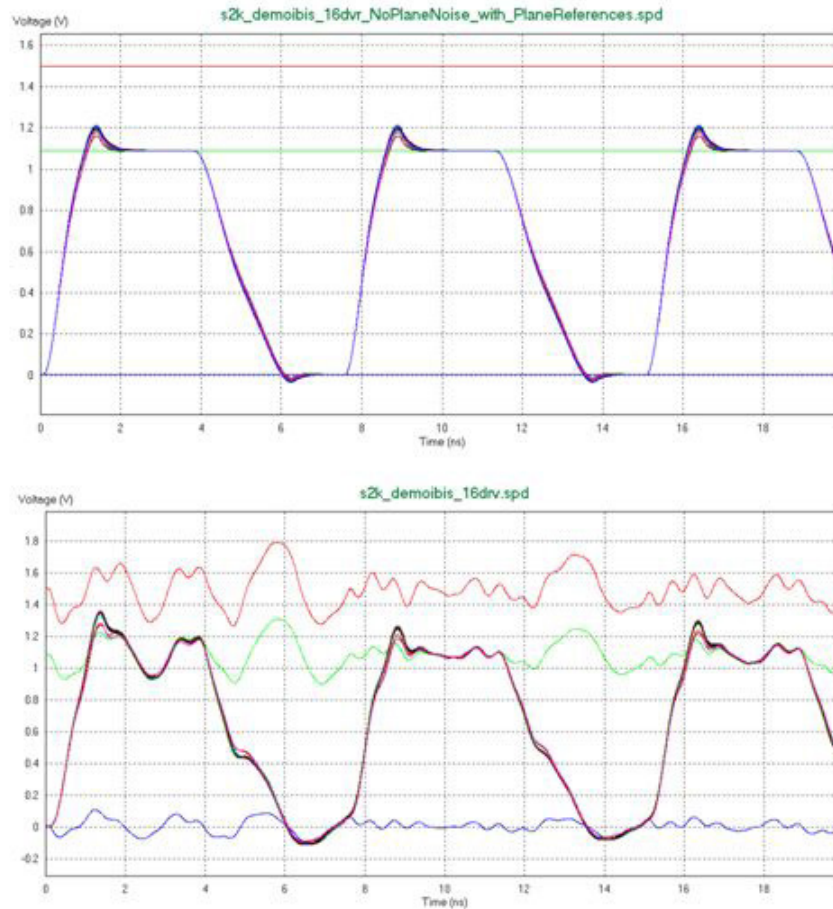

Figure 2: Signal waveforms assuming ideal and non-ideal PDN

Characterization of simultaneous switching noise (SSN) effects requires system-level transient analysis, including transmit and receive buffers and all interconnect in between. Unlike for SPICE, real circuits may not apply a global ground (node 0) and all signals are referenced to local power/ground pads. Therefore, not just the interconnect, but the associated PDN must also be included in this system model.

The system interconnect includes an on-chip path from the active silicon transmit buffers to external die pads, the package, a PCB, and possibly a motherboard; the same components are on the receive side of the system. The on-chip portion of the system is typically modeled as a spatially distributed lumped RC (more recently RLCK) SPICE circuit. Low-speed packages are represented by RLCK lumped models and higher frequency packages by S-parameters. PCBs are large enough that lumped element models rarely apply and S-parameters are typically used. These non-lumped, broadband frequency domain models imply a difficult transient simulation even without the nonlinear buffers included.

Because most SI software tools were created in an era where the timing effects of SSN could be ignored, many tools perform SI analysis assuming ideal power and ground rails. However, with the margins becoming so tight, assuming ideal power and ground could cause prototypes to fail or, worse yet, data integrity problems on production hardware in the field.

Savvy SI engineers are now insisting that their memory interfaces be analyzed considering the effects of signal and non-ideal power/ground. This is now being referred to as “power-aware” SI analysis. Modeling of I/O buffers can now follow an updated IBIS standard (IBIS 5.0+) where power-aware IBIS models allow SI tools to consider the parasitics of the power and ground connections as well as the signals. With the DDR4/LPDDR4 interfaces taking on serial link characteristics, and considering DDR4 JEDEC specs (Figure 3) now specify a target BER (for SERDES interface specification originally), the analysis techniques, traditionally used for multi-Gbps interfaces, also must be introduced to analyze DDR4 designs.

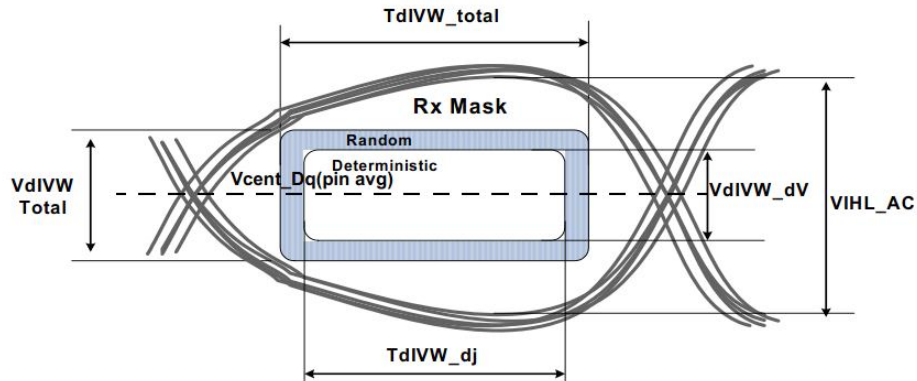

Figure 3: DQ receiver compliance mask from JEDEC for DDR4 measurement

This paper will walk through the I/O modeling, interconnect modeling, simulation, and analysis challenges associated with power-aware SI of today’s high-speed memory interfaces and how modern tools can be used to address these challenges.

Power-Aware I/O Modeling

Transmit and receive buffers are critically important IP to both fabs and fabless design companies. They are either extracted at a detailed netlist level by cell characterization software or carefully crafted manually by I/O designers. These models are then encrypted and distributed only under strict non-disclosure agreements. Each individual buffer includes many transistors. These buffer circuits suffer from slow convergence during SPICE simulation even with ideal lumped loads.

Full-bus SSN characterization requires hundreds, in some cases literally thousands, of transistors combined with broadband frequency domain models. Such simulations are extremely resource intensive and sensitive to SPICE convergence issues. Typical simulation times are measured in days and memory consumption in double or even triple digit gigabytes when performed on high-performance computer platforms.

IBIS buffer macromodels are commonly applied for system-level SI simulations instead of transistor-level netlists (Figure 4). Simulation time, memory consumption, and convergence issues are all dramatically reduced versus transistor-level simulation. However, in the past it has been well known that IBIS models are not amenable to SSN simulations because 4.2 and previous versions did nothing to assure proper power/ground buffer currents.

IBIS 5.0 was enhanced to address this situation. Updates called BIRD-95 and BIRD-98 were added to the specification to model power currents and their fluctuations with respect to PDN voltage noise. Together, these two updates provide an accurate modeling of buffer power currents and enable IBIS 5.0-compliant models to be applied for full-bus SSN characterization.

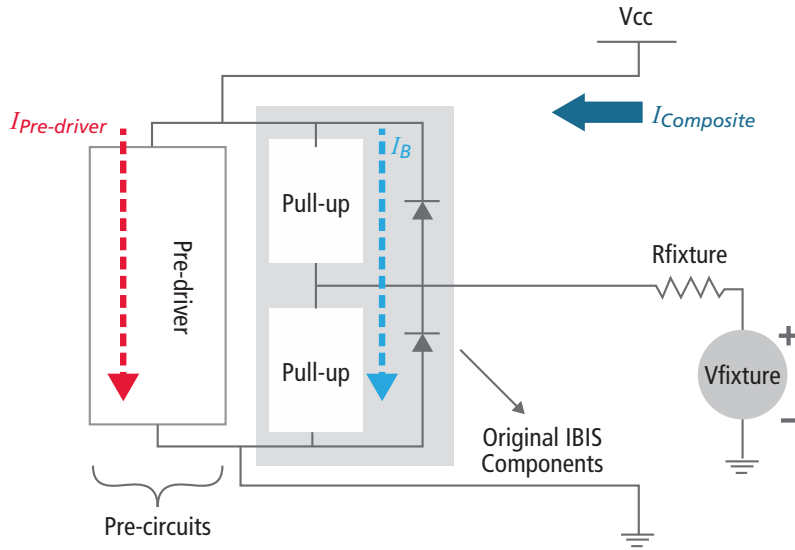

Figure 4: Schematic of behavioral I/O model

Not all SI software presently supports application of IBIS 5.0 buffer models for power-aware SI analysis, but it is becoming more common. Commercial solutions are now available to support conversion of transistor-level buffer models to IBIS 5.0 behavioral macromodels (Figure 5).

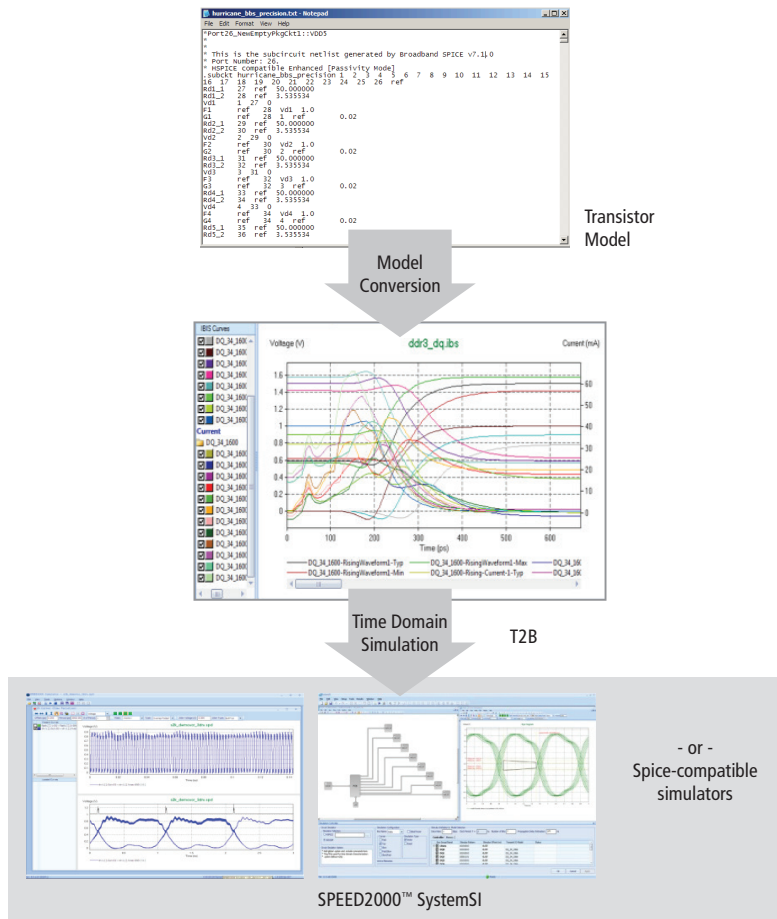

Figure 5: Cadence® Sigri™ Transistor-to-Behavioral (T2B™) I/O model conversion

These are easily applied by fabs, fabless design companies with their own IP, and even designers who may be provided only transistor-level models. Semiconductor vendors are moving toward providing IBIS 5.0 models. If such models are not available from their website, they may well be available for internal application or distribution to designers under non-disclosure. IBIS 5.0 buffer models address IP sensitivity issues that exist for transistor-level netlists (even encrypted netlists) and eliminate the need to disclose process parameters.

Because of the introduction of serial link design techniques in DDR4 and LPDDR4 interfaces, the above simulation solutions are not enough. To keep up with the design changes for DDR4 and LPDDR4 devices, the corresponding I/O modeling scheme now must move from pure analog to Algorithmic Model Interface (AMI), so that the FFE filtering functions in a controller can be captured correctly.

Interconnect and PDN Modeling

One of the key challenges in enabling a power-aware SI methodology is the extraction and modeling of interconnects, such as PCBs. Historically, this has been done by extracting transmission line models (e.g., SPICE “W” elements) for signal traces, while assuming they are routed adjacent to an infinite, solid reference plane. Signal vias are often modeled using a fast closed-form approach as isolated, uncoupled objects with only self-parasitics (i.e., ideal return paths). This kind of technique is very convenient mathematically as it enables extractions that are relatively inexpensive from a computational standpoint. However, this approach completely ignores the PDN, forcing an undesirable “ideal power” assumption upon the simulation and masking any PDN effects from the simulation results.

Incorporating the PDN into the extraction process is a significant challenge. It involves the extraction of the copper shapes that typically comprise the power and ground planes, as well as vias that run through them, along with the coupling to the signal traces. These vias essentially act as radial transmission lines, which excite the parallel plate plane structures, perturb the power supplied to the chips, and couple noise back onto the signals.

Decoupling capacitors must also be modeled and incorporated into the extraction, as should models for the voltage regulator module (VRM), which is where power is brought into the PCB from the external world. Once the extraction problem expands from “signals and vias” to “signals, planes, and vias,” the simple transmission line extraction techniques that have been historically used are no longer applicable, and the problem requires some kind of full-wave-based solution.

Traditional full-wave field solvers address the full set of Maxwell’s equations, with no (computationally) simplifying assumptions. Full-wave engines are certainly able to handle all of the structures discussed previously, but come at a major computational cost. From a practical standpoint in a typical design schedule, it may only be possible to extract a few signals and some small portion of the PDN using purely full-wave techniques. While this may be quite accurate for this small portion, it does not enable modeling on the scale desired for the power-aware SI problem. What is generally desired is to include a significant number of bus signals, for example 16 or 32 of them, to include the cumulative effects of simultaneously switching outputs (SSOs).

The entire PDN for the bus needs to be extracted as well, including the power and ground planes from the stack-up, and the associated decoupling caps. To provide extraction and modeling on this scale, a different approach must be taken.

Technology is available today that attacks this daunting problem in a unique manner. Using a patented “hybrid solver” technique, the layout is decomposed into traces, vias, planes, and circuits (e.g., for decoupling cap models). These elements are sent off to specifically tuned solvers optimized for these structures, and their results are integrated back together into comprehensive S-parameters. This technique provides nearly full-wave accuracy, while at the same time enables very large-scale problems to be handled in a reasonable amount of time. These S-parameters can be simulated directly in the time domain, or optionally converted into BroadbandSPICE models, providing even better time-domain simulation performance (Figure 6).

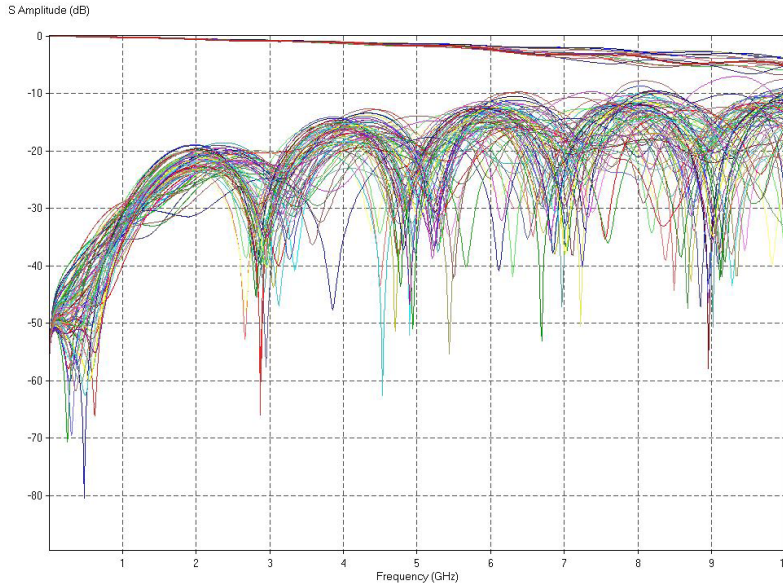

Figure 6: Extracted PCB S-parameters from Sigurity PowerSI™ technology

Simulation Environment

The challenges with regards to simulation environment in the context of power-aware SI fall into several categories: bus modeling, the time-domain simulation itself, and post-processing of results. The bus modeling challenge comes once the models are available for the I/Os, decoupling caps, and passive interconnect. At that point, it becomes necessary to build out or represent the entire die-to-die topology of the bus of interest for simulation. It is generally convenient to do this in a schematic-like environment, where the bus is easily visualized across chip, package, and board fabrics.

There are a few enabling features of a schematic-like environment that facilitate analysis. One of these is hierarchical connectivity, which is in contrast to the “wire-by-wire” connectivity found in traditional schematic-based tools. Wire-by-wire connectivity, in which each individual wire is shown from terminal to terminal in the schematic, works fine with smaller topologies. But as you look to model large groups of coupled signals, together with multiple power and ground connections in each model, this approach quickly becomes impractical. In a hierarchical connectivity approach, only a single connection is shown between models, with the explicit wiring details available one level below. This enables significantly large bus topologies to be easily constructed for analysis (Figure 7).

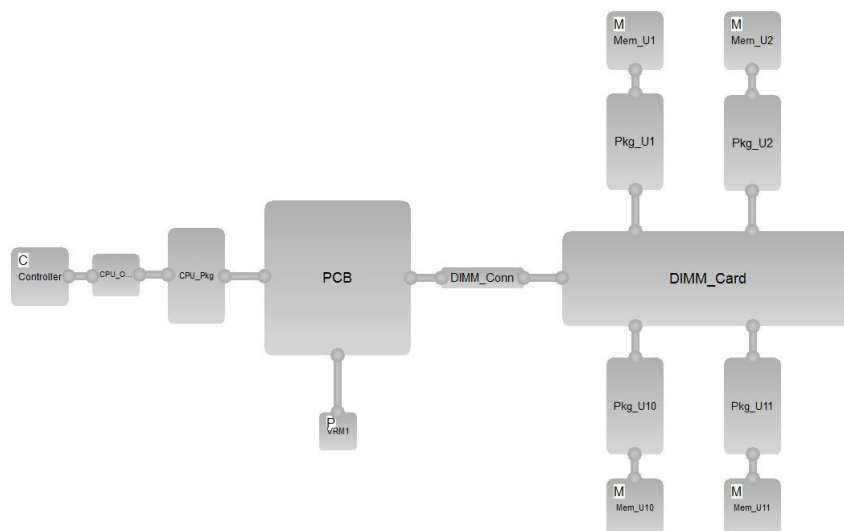

Figure 7: Bus topology in Sigurity SystemSI™ technology

With regards to the simulation itself, it appears that this would be straightforward, but there are still some things to consider. SI tools have historically broken down a bus-level problem into multiple piecemeal parts, such as running uncoupled single-line simulations on individual signals to gather delay data, then running other partially coupled subsets of the bus to gather some coupling-related effects, and then trying to combine the results together afterward (SSO is typically ignored altogether). This kind of divide-and-conquer approach worked well when the margins were relatively large, but the margins on a modern DDR data bus with data rates well over 1Gbps, such as DDR4 designs at 2.133Gbps, are substantially different than those of the 333Mbps DDR data buses of yesteryear, when those techniques were commonly deployed.

In hardware, reflections and inter-symbol interference (ISI) do not occur independently of crosstalk or SSO. These effects all happen together, where each affects the other. They cannot be cleanly separated. The simulation needs to much more closely emulate the behavior of the hardware, which boils down to essentially running the entire bus structure in one large simulation. In this manner, all the interplay and interactions between these major effects are captured in the results. The other benefit of this approach is that raw setup and hold measurements can be taken directly, the same way one would measure it in the lab with an oscilloscope.

Since the DDR4 and LPDDR4 standards specify targeted BER, traditional bus simulation in time domain cannot satisfy this requirement. A channel analysis solution is applied to the data bus to generate detailed eye distribution, from which (with dual statistical post-processing) bathtub curves can be produced, just like when a channel analysis tool is used with serial link designs. The bathtub curves provide key insight into the BER performance of the interface, which is what an SI engineer or a designer really needs, no matter if working on parallel memory interfaces or serial links.

Post-Processing and Analysis of Results

Once the simulation results are available, the next challenge is to automate the post-processing of the raw waveforms in order to take measurements, generate reports, and close timing. There are a multitude of measurements that are called out per the latest JEDEC specifications for DDR memory interfaces. To do this comprehensively, measurements must be taken for each signal, on every cycle. This produces a tremendous amount of data very quickly, so plots of the data are very useful in evaluating the design, as opposed to just generating spreadsheets with many rows.

Another key aspect of the post-processing is to automate the derating of setup and hold times (Figure 8).

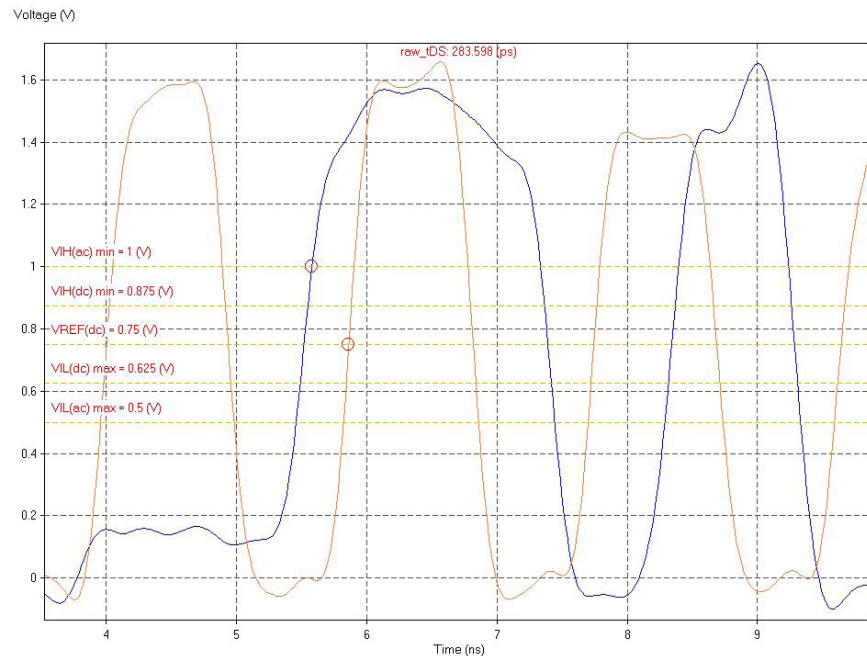

Figure 8: Setup measurement

Per JEDEC specifications, the slew rates of the signals determine how much more or less setup and hold time is required at the memory, on top of the base setup and hold requirements. What this means for the case of a data bus is that the slew rates of the data and strobe signals need to be automatically measured at each cycle. Then from those two pieces of data, a lookup table provides the incremental setup and hold delta that applies for that cycle, and a final setup and hold margin can be determined, again for that cycle. This needs to be repeated on each cycle for all signals. Again, the amount of data accumulates very quickly, so automation is critical (Figure 9).

Delta_tDS (ps) —AC250 tDS Derating Values for DDR2-400/533										
		DQS Single-Ended Slew Rate (V/ns)								
		2.0 V/ns	1.5 V/ns	1.0 V/ns	0.9 V/ns	0.8 V/ns	0.7 V/ns	0.6 V/ns	0.5 V/ns	0.4 V/ns
		Delta_tDS	Delta_tDS	Delta_tDS	Delta_tDS	Delta_tDS	Delta_tDS	Delta_tDS	Delta_tDS	Delta_tDS
DQ Slew Rate (V/ns)	2.0	188	167	125						
	1.5	146	125	83	81					
	1.0	63	42	0	-2	-7				
	0.9		31	-11	-13	-18	-29			
	0.8			-25	-27	-32	-43	-60		
	0.7				-45	-50	-61	-78	-108	
	0.6					-74	-85	-102	-132	-183
	0.5						-128	-145	-175	-226
0.4							-210	-240	-291	

Figure 9: Derating table

To handle the large quantity of data and close timing, the automated reporting needs to post-process the data and provide intelligent summaries to show critical results such as:

- Positive setup and hold margins for address/command and control buses, and for data bus “write” transactions at the memory devices
- Skew requirements are met at the controller for data bus “read” transactions
- Strobe-to-clock skew requirements are met

In the case of DDR4 and LPDDR4 simulation, additional information is generated from channel analysis results to report the eye mask and its margin, bathtub curves, and BER.

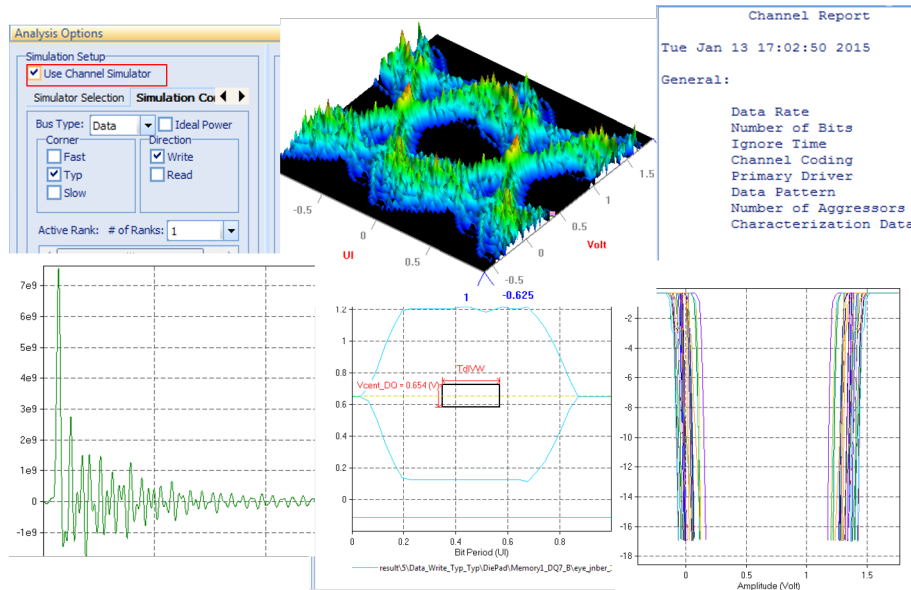

Figure 10: DDR power-aware signal integrity adopting serial link simulation techniques

Summary

Moving from an ideal power assumption to a power-aware SI methodology requires some upgrades to your modeling and simulation techniques, and is required for adequate SSN characterization of modern memory systems.

A key enabler is power-aware I/O modeling, allowing SSN simulations in minutes on a laptop instead of days on a large server. Thankfully, from the release of IBIS 5.0 and onward, there is an industry-standard way in which this can be done, and tools are available to automate the generation of these models from transistor-level netlists. Demand by systems engineers will quickly drive the broader availability of these I/O models from component suppliers.

Tools to perform efficient interconnect and PDN extraction have been available in the market for a number of years, and are becoming increasingly mainstream for SI applications as the number of DDR3 and DDR4 design starts increase over time. Simulation environments also require advancement to handle complex bus topologies, comprehensive simulation, and highly automated post-processing to analyze today’s challenging interfaces.

With a combination of complete model libraries, advanced tools, and engineering expertise, today’s SI engineers have the means to thoroughly address the challenges associated with today’s modern buses and data rates.



Cadence Design Systems enables global electronic design innovation and plays an essential role in the creation of today’s electronics. Customers use Cadence software, hardware, IP, and expertise to design and verify today’s mobile, cloud and connectivity applications. www.cadence.com